

Installation and User Manual

Non electricity bill ,
water pressure type shower toilet seat

TYPE: SG-001
SG-002

kirei

- Thank you for purchasing the BIDET . Please read through the manual carefully for appropriate use of the product.
- After you read through the manual, keep it at a proper place for further reference.

1	Names of Parts -----	1
---	----------------------	---

2	Installation -----	3
	• Precautions -----	3
	• Installation -----	3
	Pre-installation -----	3
	Installation Procedure -----	4
	Connecting Water Hose -----	5
3	Operation -----	6
	WASH -----	6
	BIDET -----	6
	STOP-----	6
4	Clean and dismantlement -----	7

How to install movie



5	Product Maintenance -----	8
6	Self Diagnosis and Specifications -----	9
	Self Diagnosis and Trouble shooting -----	9
	Specifications -----	9
	Warranty -----	

1 Names of parts

Product

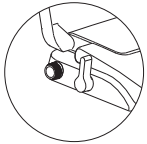

Water inlet on the left

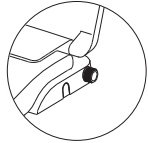

Water inlet on the right

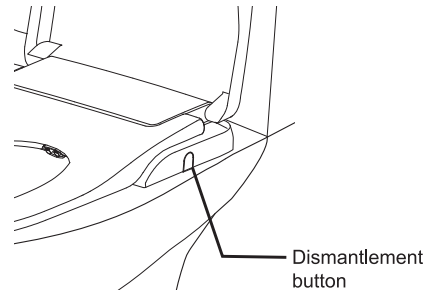

Dismantlement button

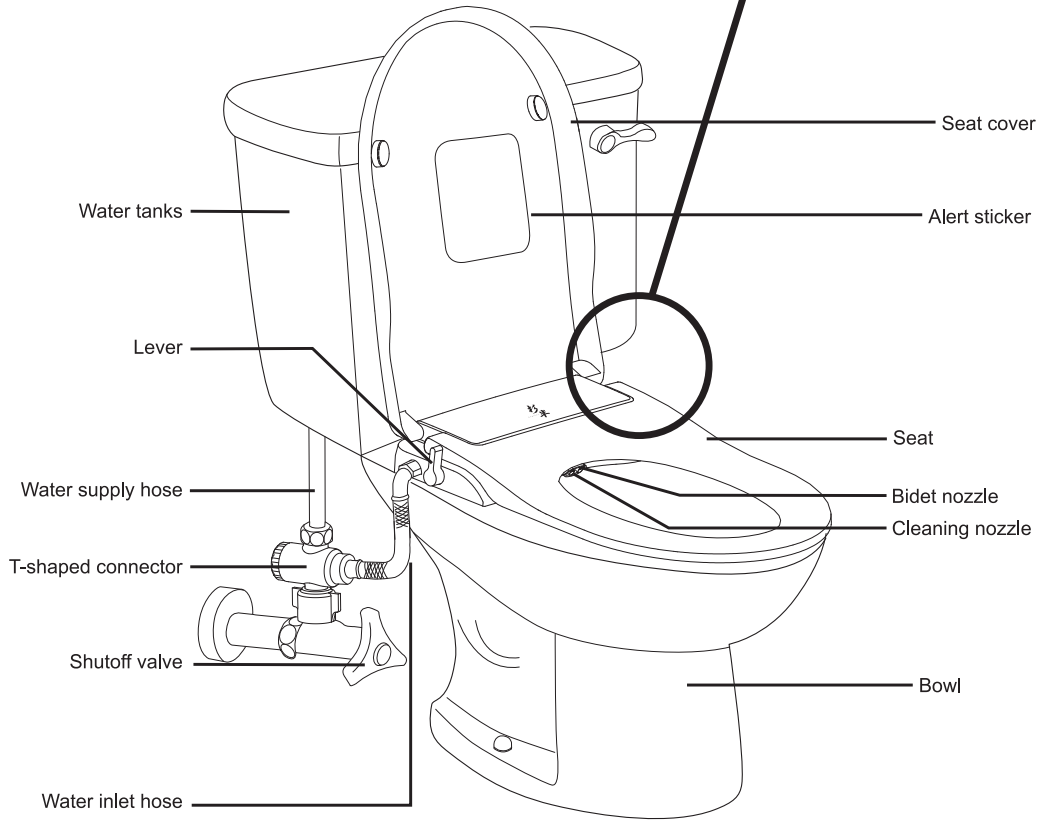

Components

1.Main body

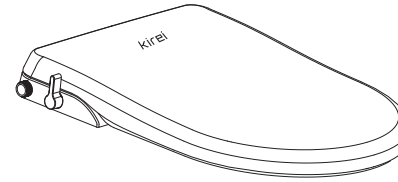

2.Installation template

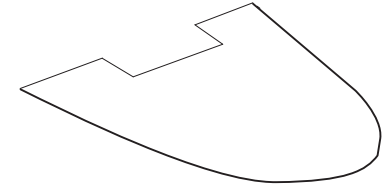

3.Fixing Components

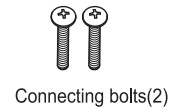

Connecting bolts(2)



Expansive nuts(2)



Nut(2)

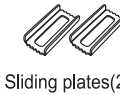

Sliding plates(2)

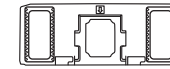

Adaptable panel

5. T-shaped connector

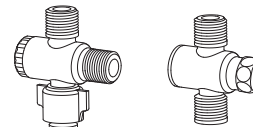

Plastic OR Metal

6. Water hose

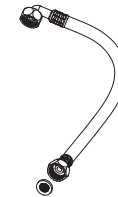

Ring Gasket

7.Installation and User Manual



Note:

There are two methods for installation. The way of employing expansive nuts is recommended. Another way is using butterfly nuts. Please choose one for specific case.

2 Installation

Please make sure you read the instructions carefully and install it properly.

■ Cautions

1. The water pressure limit is from 0.07 to 0.8 MPa (10 to 116 PSI). Please use as instructed.
2. The water shutoff valve should be near where the product can be installed and dismantled.

■ Product Installation Procedure

■ Pre-installation

1. Insert the connecting bolts in adjusting pieces.

- As figure, insert the connecting bolts in the holes of adjusting pieces.

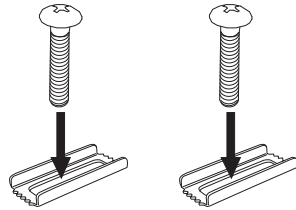

2. Insert connecting bolts with adjusting pieces in the adaptable panel.

- As figure, insert the connecting bolts in the holes of adjusting pieces in the holes of the adaptable panel.

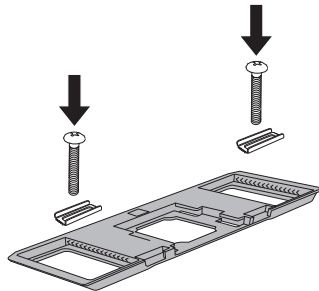

■ Installation Procedure

• First installation method (recommended):

1. Dismantle the old seat and seat lid.
 - Loose the hinge and remove the old seat and seat lid.

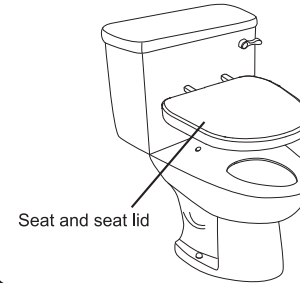

2. Install expansive nuts

- As figure, insert expansive nuts in the holes of the ceramic.
- Please do only when you can not tight the nut from the bottom of the toilet lid

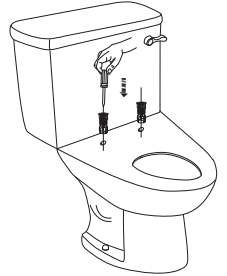

3. Install installation template

As figure, install the installation template on the ceramic.



4. Fix the adaptable panel

- As figure, take the adaptable panel to the holes of the ceramic. Adjust position for connecting bolts and adjusting pieces, make the connecting bolts aim at according expansive nuts. Then fix the adaptable panel.
- Keep the side with FRONT up

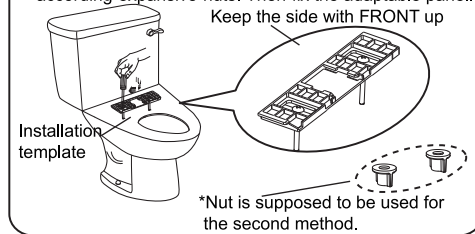

5. Take away the installation template

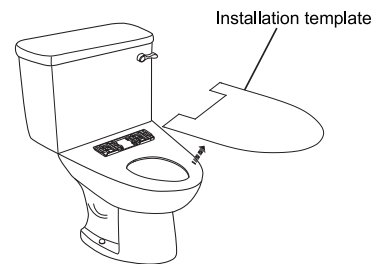

6. Install the product

- Keep the fix slots under the product aim at slots on the adaptable panel. Push the product to the end as figure below. Then completes installation.

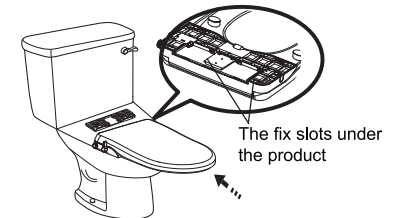

• Second installation method

1. Refer to first installation method step 1 and 3. Dismantle the old seat and lid. Put the installation template on the ceramic.
2. Refer to first installation method step 4. Take the adaptable panel to the holes of the ceramic. Adjust position of the connecting bolts with adjusting pieces. Screw in the nuts from underside of the ceramic. Then fix the adaptable panel.
3. Refer to first installation method step 5 and 6. Complete following installation procedure.

■ Connecting water hose

1. Close the water valve and detach water pipe from the water tank. Connect the t-shaped connector to the water tank. Make sure that rubber packing is inserted in between.
When the water supply hose and the branch parts are made of plastic, be tighten by hand.

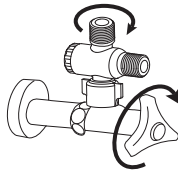

2. Connect the water pipe to the t-shaped connector.
Note: Please remove the regulator cover and regulate o-ring under the following conditions:

- a. When the water dynamic pressure is lower than 0.05MPa, especially using the family tank.
- b. When the nozzle cannot work normally and water is low.
 1. Take out the regulator with pliers and other tools.
 2. Remove the regulator cover and regulate o-ring except the sealing o-ring.
 3. Insert the regulator component into the inlet pipe.

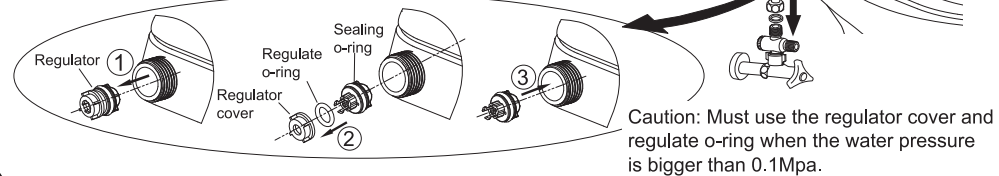

3. Press the filter and washer at the two ends of water hose into the screw tube, then connect the main body and T-shaped connector with water hose.

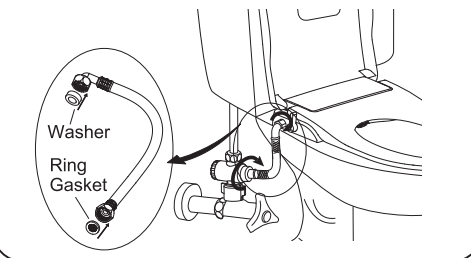

4. Open the water valve to check if there is any leakage.

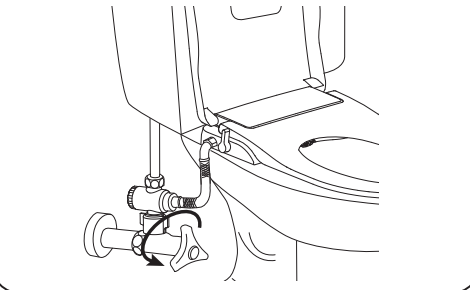

⚠ Notice: When the water stopcock and the toilet bowl (flash tank) are connected by a water supply pipe that cannot be bent

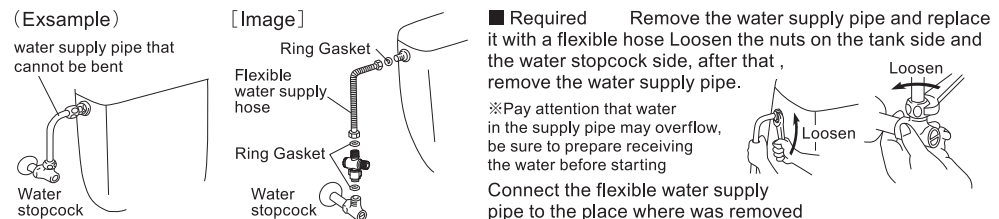

3 Operation

■ WASH

- Turn the lever clockwise from the horizontal position.
- Nozzle for WASH moves forward and start the function.
- The water volume changes with the turning of lever.

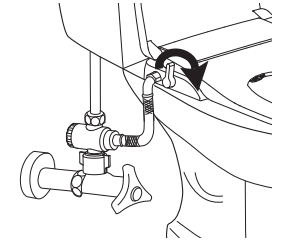

■ BIDET

- Turn the lever anticlockwise from the horizontal position.
- Nozzle for BIDET moves forward and start the function.
- The water volume changes with the turning of lever.

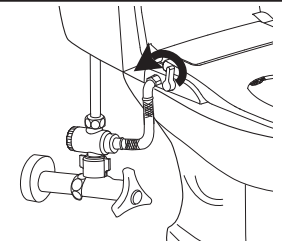

■ STOP

- During wash or bidet status, rotate the knob to horizontal and stop douche.
- Nozzle moves back to original position.
- The water volume changes with the turning of lever until totally shut off.

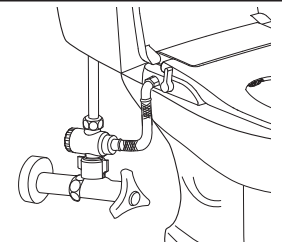

1. Do not lift the product with the seat cover and seat open. This may cause a mechanical trouble.
2. Cannot use with the hot water which temperature is higher than 40 ° C .

4 Clean and dismantlement

1. Clean the outside parts of the product.

Use a smooth sponge/cloth with diluted kitchen detergent to clean the product. Do not use the following types: hydrogen chloride detergent, painting thinner, benzene, abrasive paper, polishing agent, fragrance and insecticide, etc.

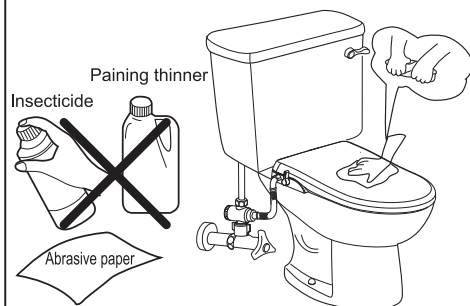

2. Clean the nozzle

Pull out the nozzle softly and use smooth cloth/sponge or toothbrush with kitchen detergent to clean the nozzle.

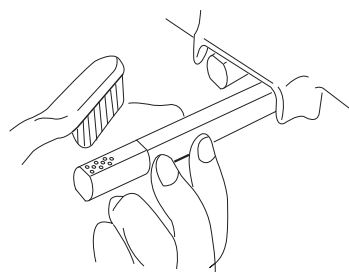

3. Clean the filter and regulator

(If the water flow is smaller than usual)

1. Clean the filter for both sides. Make sure to disconnect the water supply hose during cleaning.
2. Clean the regulator o-ring (See the step 2 on the page 5 to find how to remove and install the regulator o-ring).

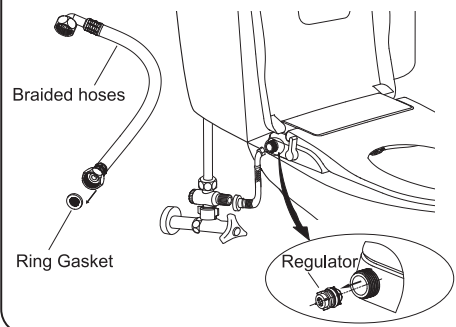

4. Remove the main body.

Close the lid. Push the dismantlement button and pull out the product as the arrow the figure. Then the product will be dismantled.

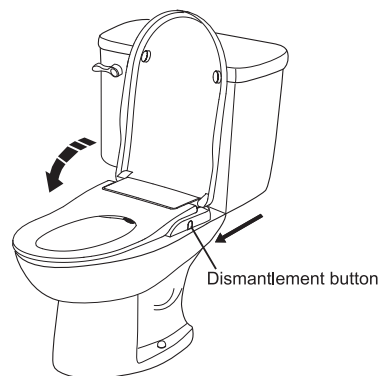

5 Product maintenance

1. Lever replacement

As per figure A, Remove the old lever along the axis direction.

As per figure B, insert the new lever rib into the corresponding control valve slot. The installation is completed with a "click" sound.

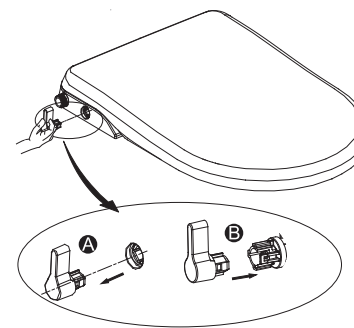

2. Nozzle replacement

As per figure A, Pull out the tube and do not release then remove the old nozzle along the axis direction.

As per figure B, insert the new nozzle into the tube along the corresponding slot. The nozzle replacement is completed.

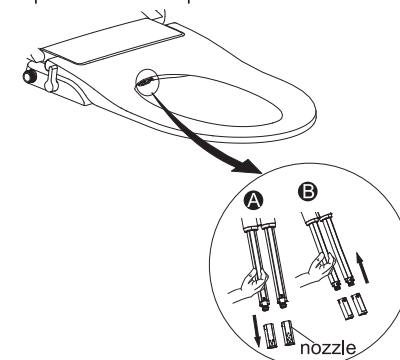

3. Regulator replacement

Rotate the lever in the working position, clip out the regulator from the inlet tube by pliers.

Press the new regulator into the bottom of the inlet tube. The regulator replacement is completed. Then rotate the lever back to non-working position.

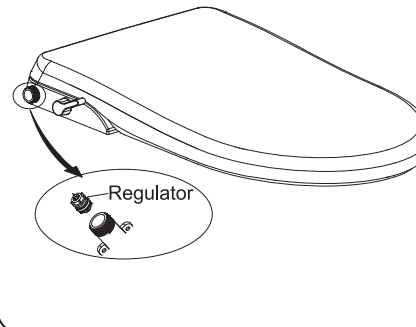

4. Water hose leaking solution

If water leaks from the two ends of water hose, re-tighten the nuts to avoid water leaking.

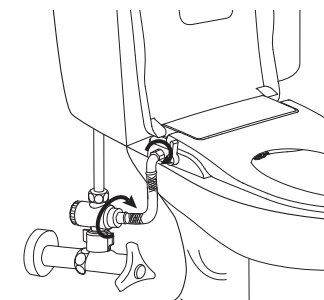

6 Self Diagnosis and Specifications

Self Diagnosis and Trouble shooting

Status	Cause	Solution
Water is too low during WASH/BIDET	1. Low water pressure of the unit	During WASH/BIDET, turn the lever fast to biggest volume
	2. Low water pressure of water supply	When water supply pressure is lower than 0.7kgf/cm ² , contact local department for water pressure question
No water comes out during WASH/BIDET	1. Water shut-off valve is turned off	Turn on the water shut-off valve
	2. Filter net of T-shaped connector is stuck	Clean the filter net of T-shaped connector
	3. Filter net of water inlet hose is stuck	Clean the filter net of water inlet hose
	4. Nozzle head is stuck	Take off and clean the nozzle head.
	5. External water pressure is low	Increase external water pressure.
Water dropping from bowl when using the unit	External water pressure is too big	The maximum water pressure of the unit is 0.8MPa . If water supply pressure is higher than that, please contact local department for water pressure question.

If any failure still occurs after above trouble-shooting, please contact local service.



Do not disassemble, repair or remodel the unit.

Specifications

Classification	Description	
Model No.	SG-001 / SG-002	
WASH water flow	0.35 - 1.8 L/min	
BIDET water flow	0.35 - 1.8 L/min	
Backflow Prevention	Check valve, vacuum breaker	
Water Supply	Direct from water pipes	
Water Pressure Range	Static pressure:0.07- 0.8 MPa,Dynamic pressure:above 0.03MPa	
Dimensions	SG-001 / SG-002	370X500X60mm
Weight	SG-001 / SG-002	2.23 KG / 2.30 KG

Warranty Card

The warranty period of product is 12 months from the receipt of the proof of purchase and coverage is valid only in the country of purchase.

※Please note that items without a receipt will not be covered by the compensation.

Dear Customer,

Thank you for choosing the product! If failure or damage occurs, please check the product based on the trouble shooting guide in this manual first. If the failure/damage could not be fixed, please contact the retailer or local service center with proof of purchase.

A. Related Info:

Customer	Name:		
	Address:		
	Tel.:		
Retailer	Name:		
	Tel.:		
Model No.		Series No.	
Date of Purchase		Warranty time	1 Year from the date of purchase

B. Notes about the warranty card:

1. Please make sure that the above info is completed in the warranty.
2. This Warranty and invoice are important documents for product maintenance. During warranty period, when the retailer or service people come for product maintenance, please present the Warranty and invoice.
3. This warranty cannot be reissued. Keep it in a proper place.

C. Free repairment policy:

During warranty period, if product failure/damage occurs under normal operation according to the user manual, free repair service will be provided.

D. The following repairment or maintenance should be paid:

1. Failure occurs out of warranty period;
2. If this warranty/invoice is not presented;
3. Failure/damage occurs due to transportation/collision of the product after purchase;
4. Failure/damage occurs due to natural disasters such as fire, earthquake, flood damage, lightning or by environmental pollution, gas and abnormal voltage;
5. Failure/ damage due to user's responsibility, improper repairment or reassembling of the product;
6. Failure/damage due to improper cleaning of product (e.g. improper use of detergent or cleaning method);
7. Failure/damage due to sand, junk or other unexpected goods from water supply;
8. Relocation of the product up to end user's requirement.



Saller: Sugihan Corporation
 URL: <http://sugihan.com/english/>
 When you have any questions, please contact us by using the contact form on our website.

■ **To request service:**

1. Please recheck the user's manual.
2. If failure or damage occurs after referring the manual, stop using the product and contact the retailer or local service center.